

Flap Barrier Turnstile



Flap Barrier Turnstile precisely control single-person passage through synchronously opening and closing barriers, featuring anti-tailgating and multiple verification functions, making them a key piece of equipment for managing high-density crowds in subways, stadiums, and other similar locations..

Flap Barrier Turnstile AT313

Technical Specifications

Product dimensions:	1410*310*994mm;4.62*1.02*3.26 ft (standard; customizable)
channel width	Standard: 600 mm (1.97 ft); Optional wing within wing: : 900 mm (2.95 ft)
Net weight of the turnstile:	68KG
Enclosure material:	304 stainless steel + iron paint
Door arm material:	Acrylic
Channel direction:	One-way/Two-way
Mechanism type:	Full-height movement, equipped with a DC motor
Infrared sensors:	5 pairs
Passage rate:	40 people/minute; Runtime: 0.2 seconds
Power supply:	Input: AC100V-240V, Output: DC24V, DC12V
Enable signal:	Relay signal, 12V level or 12V pulse signal with a pulse width \geq 100ms (dry contact)
Communication method:	RS485/RS232F
Operating temperature:	-35°C to 60°C; relative humidity: 5% to 95%.
Work environment:	indoor
Safety mode:	Barrier-free access after power failure.

Feature

- 1.Traffic indicator lights: Standby blue, pass green, prohibit red.
- 2.Alarm function: Infrared sensor alarm function, used for unauthorized intrusion and reverse intrusion situations.
- 3.Emergency exit function: Allows free passage in case of emergency or power outage, and automatically resets after power is restored.
- 4.Automatic Reset: If a user fails to pass through the designated area after swiping a valid card, the system will automatically revoke the user's access permission.
- 5.Collision protection: When the door panel experiences an impact exceeding safe limits, the robotic arm will automatically return to its original position without damage.
- 6.Reverse Entry: If someone attempts to enter from the opposite direction, the door will remain locked.
- 7.Anti-tailgating: If multiple people pass through without permission, the gate will sound an alarm. Security Level 2.
- 8.Anti-intrusion function: The door automatically locks before receiving a valid open signal. When a valid signal is received, the door will unlock within 0.2 seconds (adjustable).
It offers multiple operating modes: one-way passage, two-way passage, infrared gate opening, or passage controlled by a gate opening signal sent to the main board, all of which can be set through the main board menu;
- 9.Logical judgment: Multiple sets of infrared sensors monitor the channel status in real time, and accurate logical judgment enables unimpeded access authorization.
- 10.Traffic Mode: Both entry and exit directions can be independent to **【Controlled Traffic】 / 【Free Traffic】 / 【No Traffic】**.
- 11.Passage request memory function: When two or more valid passage signals are given at the same time (including same direction and opposite direction), the system will remember all passage requests and complete each passage action in sequence (the number of requests to be remembered and whether to select the memory function can be customized according to customer requirements).
- 12.Safety features: Equipped with lightning protection and leakage protection functions
- 13.Voice prompt function: Provides voice prompts when entering and exiting; multiple voice prompts can be set (customizable).
- 14.Interface Protocol: A free development kit protocol is provided, facilitating control and debugging, and offering strong scalability.
- 15.Multi-level anti-collision buffer function: When illegal passage or gate rushing occurs, the gate arm buffers at the corresponding angle and activates the instantaneous reverse thrust and clutch lock, while simultaneously activating the alarm. This not only achieves humane protection against injury but also greatly reduces mechanical damage caused by frequent or continuous collisions.



PASSING SPEED



BI-DIRECTION



POWER SUPPLY



ANTLTAILGATING



PROTECTIVE LEVEL

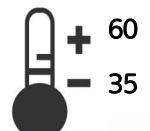









TEMPERATURERANGE

Customization

- 01 Size: Can be customized according to customer's site conditions
- 02 Materials range from 304 stainless steel to 316 stainless steel (for humid environments), or powder-coated iron. The outer paint finish can be painted to match the environment. Swing arm materials include glass, acrylic, and stainless steel.
- 03 LED control arms are optional. The control arms are more visible in the dark.
- 04 Optional double-layer retractable flap arms, with a pass-through width of up to 900 mm (suitable for wheelchairs and luggage).
- 05 Folding arm colors: Transparent, available in blue and red.
- 06 Lights and infrared sensors can be added.
- 07 It can be equipped with a mounting base (for floor wiring) and a detachable base (for temporary installations).
- 08 The card slot can be customized to fit any card reader. The swipe icon can be removed.
- 09 The logo can be customized.
- 10 Customized renderings and installation dimension drawings can be provided based on on-site photos.
- 11 We offer OEM and ODM services.
- 12 Integrated access control system based on materials, surface treatment, and appearance dimensions
- 13 Integrated ticketing system, integrated photo system, integrated temperature control system
- 14 Install remote control button

Access control system

Our gates come with relays and RS485/RS232 interfaces. You can use your own access control system, or we can provide a complete access control system to you.

-  Remote control
-  RFID card
-  Button
-  Coin/card collection
-  Face recognition
-  Fingerprint recognition
-  QR code/ barcode
-  Counter

We also offer customization services.



The card reader window can be customized for any card

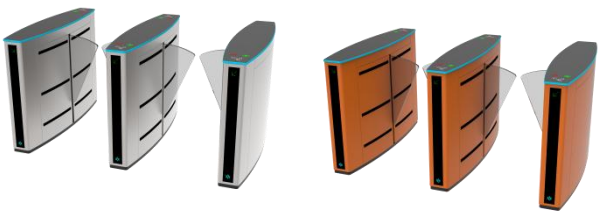

Custom colors are available, but you will need to provide RAL and RGB color charts.



Lane combination



Dimensional drawing

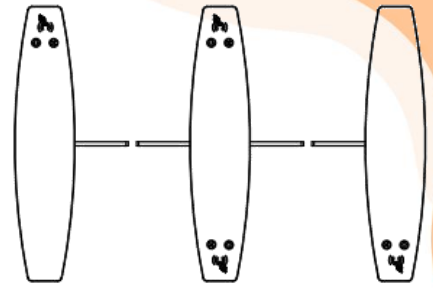
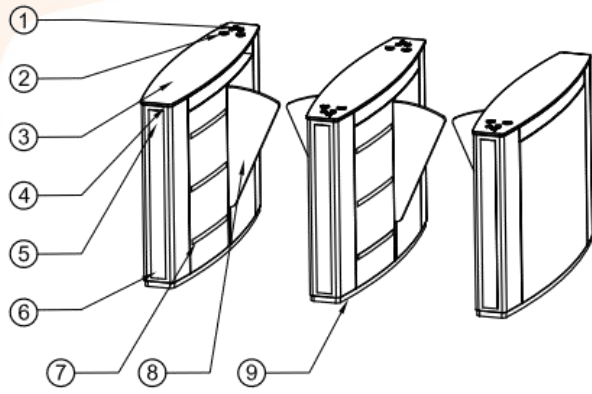

- ① Acrylic CARD Window
- ② Direction Indicator
- ③ Acrylic top cover
- ④ LED RGB traffic light
- ⑤ Lane Status Indicator
- ⑥ Lane Status Indicator
- ⑦ IR Sensor Cover
- ⑧ Acrylic Barrier
- ⑨ Position of Fixing Screw

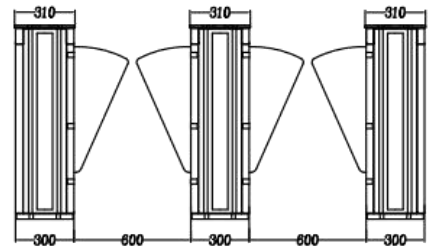
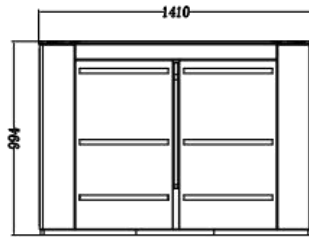

Note: 1.The standard material is SUS304.Options are 316 stainless steel, Iron with powder coated
 2.Lane width can be customized based on site requirement

Model:AT313



Email : info@aipadaturndstile.com

Site: <https://aipadaturndstile.com>

Tel :+86 191-2995-1956



www.aipadaturndstile.com



+86 191 2995 1956



info@aipadaturndstile.com