

Speed Gate Turnstile

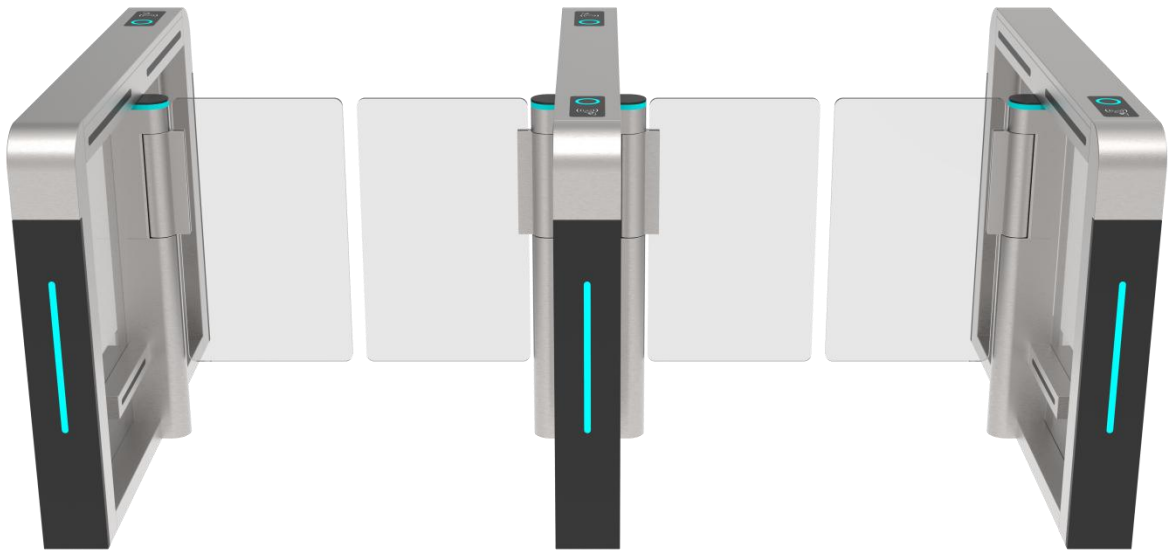

Speed gates are intelligent access control devices that enable seamless passage through rapid verification (such as card swiping or facial recognition) and have anti-tailgating capabilities. They are widely used in office buildings, subways, and other similar locations.

Speed Gate Turnstile AT403

Technical Specifications

Product dimensions:	1400*150*1000mm; 4.59*0.49*3.28 ft (standard; customizable)
channel width	600 mm (1.97 ft); -900 mm (2.95 ft) (customizable)
Net weight of the turnstile:	80KG
Infrared sensors:	6 pairs
Enclosure material:	SUS304(standard). Optional SUS316 or powder-coated iron.
Surface treatment:	Acrylic/Tempered glass/Plexiglass/Stainless steel, Swing arm height can be customized
Mechanism type	Brushless motor
Passage rate:	40 people/minute; Runtime: 0.2 seconds
Power supply: Input:	AC100V-240V, Output: DC24V, DC12V
MCBF:	3,000,000 cycles
Enable signal:	Relay signal, 12V level or 12V pulse signal with a pulse width \geq 100ms (dry contact)
Communication method:	RS485
Work direction:	two-way (standard); one-way
Operating temperature:	-35°C ~ 60°C
Relative humidity:	5% ~ 95%
Work environment:	Indoor
Safety mode:	Barrier-free access after power failure.

Feature

1. Traffic indicator lights: Standby blue, pass green, prohibit red.
2. Multiple alarm modes: Infrared sensor alarm function, including alarms for unauthorized intrusion, reverse traffic, tailgating, and exceeding the time limit;
3. Voice prompt function: Provides voice prompts when entering and exiting; multiple voice prompts can be set (customizable).
4. Collision protection: When the door panel experiences an impact exceeding safe limits, the robotic arm will automatically return to its original position without damage.
5. Anti-pinch function: Dual mechanical and infrared anti-pinch function; if the stop arm encounters resistance during reset, it will automatically stop or rebound, and simultaneously issue an alarm signal.
6. It offers multiple operating modes: one-way passage, two-way passage, infrared gate opening, or passage controlled by a gate opening signal sent to the main board, all of which can be set through the main board menu;
7. Logical judgment: Multiple infrared sensors monitor the channel status in real time, and precise logic determines unimpeded access authorization.
8. Passage request memory function: When two or more valid passage signals are given simultaneously (including same-direction and opposite-direction signals), the system will remember all passage requests and complete each passage action sequentially (the number of requests to remember and whether the memory function is selected can be customized according to customer requirements).
Safety features: Equipped with lightning protection and leakage protection functions.
9. Multi-level anti-collision buffer function: When illegal passage or gate rushing occurs, the gate arm buffers at the corresponding angle and activates immediate counter-thrust and clutch lock-up, while simultaneously triggering an alarm. This not only provides humane protection against injury but also greatly reduces mechanical damage caused by frequent or continuous collisions.
10. Emergency exit function: Allows free passage in case of emergency or power outage, and automatically resets after power is restored.
11. Interface Protocol: A free development kit protocol is provided, facilitating control and debugging, and offering strong scalability.



30-40
PASSING SPEED



BI-DIRECTION



100-200V
POWER SUPPLY



ANTLTAILGATING



PROTECTIVE LEVEL

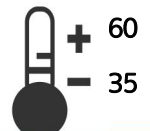

+ 60
- 35
TEMPERATURERANGE

Customization

- 01 customized to meet customer site requirements.
- 02 Materials range from 304 stainless steel to 316 stainless steel (for humid environments), or powder-coated iron. The outer paint finish can be sprayed in color to match the environment.
- 03 3. The swing arm material can be glass, acrylic, or stainless steel.
- 04 4. LED swing arm optional. The swing arm is more visible in the dark.
- 05 Lights and infrared sensors can be added.
- 06 Can be equipped with mounting base (for floor wiring) and detachable base (for temporary installations). Customized renderings and installation dimensions can be provided based on site photos.
- 07 The opening can be customized to fit any card reader. The card swipe icon can be removed. Integrated access control system (materials, surface treatments, and appearance dimensions).
- 08 The logo can be customized. Installation of remote control buttons.
- 09 Customized renderings and installation dimension drawings can be provided based on on-site photos.
- 10 We provide OEM and ODM services.
- 11 Material, surface treatment, appearance, and dimensions of the integrated access control system
- 12 Integrated ticketing system, integrated photo-taking system, integrated temperature control system
- 13 Install remote control button

Access control system

Our gates come with relaysignals and RS485/RS232 interfaces. You can use your own accesscontrol system, or we can provide a complete access control system to you.



Remote control



RFID card



Button



Coin/card collection



Face recognition



Fingerprint recognition



QR code/ barcode



Counter

We also offer customization services.



The card reader window can be customized for any card

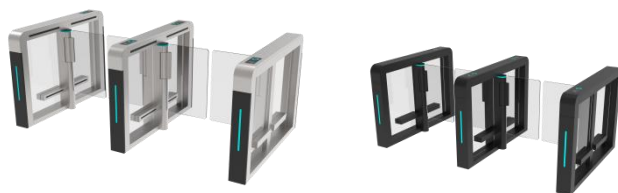

Custom colors are available, but you will need to provide RAL and RGB color charts.



Black Grey Blue Green Red

Lane combination

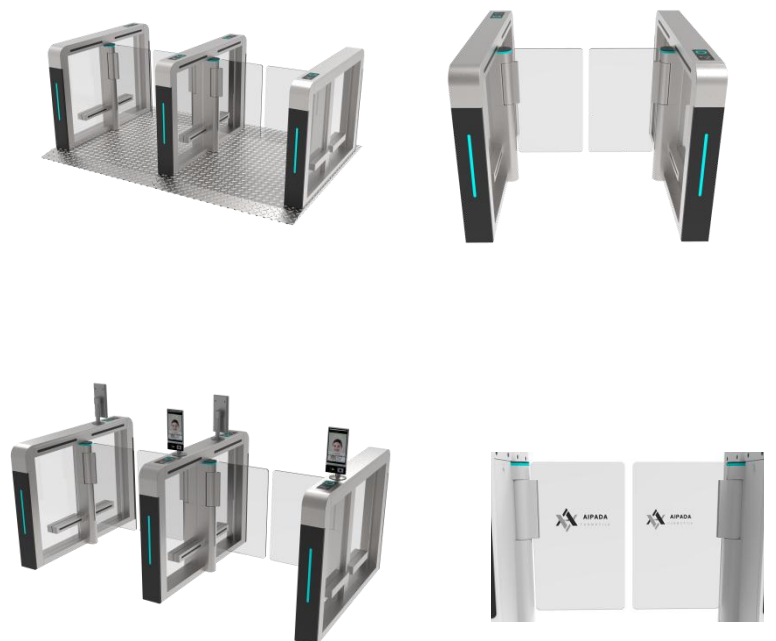

Dimensional drawing

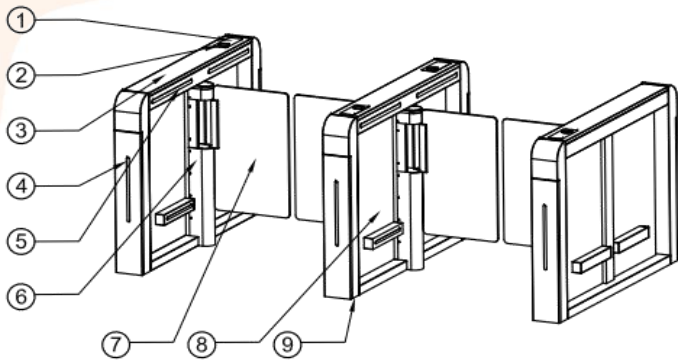

- ① Acrylic CARD Window
- ② Lane Status Indicator
- ③ Stainless Steel Top Lid
- ④ LED RGB traffic light
- ⑤ IR Sensor Cover
- ⑥ Speed Gate Mechanism
- ⑦ Acrylic Barrier
- ⑧ Widen Flap Arm
- ⑨ Position of Fixing Screw

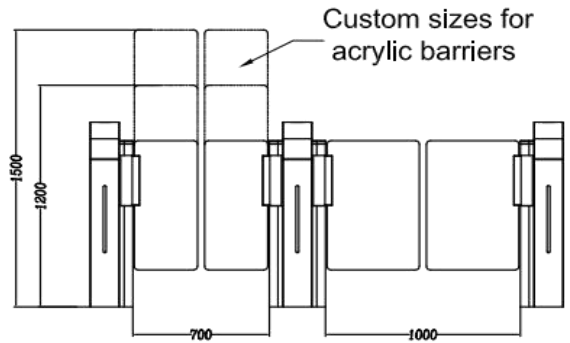
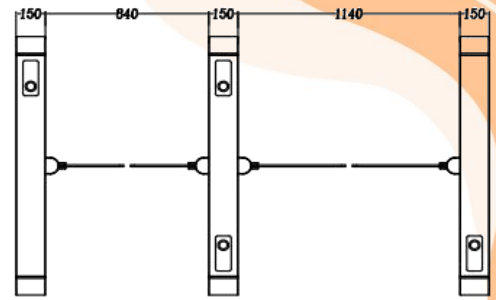
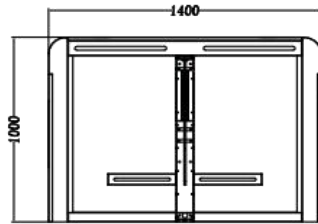

Note: 1.The standard material is SUS304.Options are 316 stainless steel, Iron with powder coated
 2.Lane width can be customized based on site requirement

Model:AT403



Email : info@aipadaturndstile.com

Site: <https://aipadaturndstile.com>

Tel : +86 191-2995-1956

